

## T-BAGS seismic base isolation system for earthquake energy dissipation

Ali Vakilzadsarabi<sup>i)</sup>, Kinji Takeuchi<sup>ii)</sup>, Yasuo Tomono<sup>iii)</sup> and Tatsunori Matsumoto<sup>iv)</sup>

i) Ph.D. Engineer, R&D Department, Takeuchi Construction Inc., 4-2-14 En-ichi-cho, Mihara-shi, Hiroshima 723-0015, Japan.

ii) CEO, Takeuchi Construction Inc., 4-2-14 En-ichi-cho, Mihara-shi, Hiroshima 723-0015, Japan.

iii) Manager, R&D Department, Takeuchi Construction Inc., 4-2-14 En-ichi-cho, Mihara-shi, Hiroshima 723-0015, Japan.

iv) Professor Emeritus, Kanazawa University, Kakuma-machi, Kanazawa-shi, Ishikawa 920-1192, Japan.

### ABSTRACT

The seismic base isolation system has been known as a practical approach to mitigate building damages in high seismic risk areas. T-BAGS is a seismic base isolation system based on sliding two stacked layers of sandbags developed by Takeuchi Construction Inc. in Japan. In this research, the static and dynamic behavior of the T-BAGS is investigated first through laboratory tests, including simple shear tests of a sandbag, shaking table tests on one set, or six sets of stacked layers of two sandbags with slip sheet between them. Then the dynamic analysis of the T-BAGS system is conducted using mass-spring modeling. The friction behavior of the interface between the sandbags is assumed to follow the force-dependent non-linear spring laws. The analysis results show that the dynamic behavior of the T-BAGS system depends on the slip material and normal force between sandbags, and input acceleration. Also, the experiment and numerical results demonstrate that the T-BAGS system has a high performance of seismic base isolation.

**Keywords:** seismic base isolation, sandbags, slippage, T-BAGS system, physical modeling, numerical modeling

## 1 INTRODUCTION

Several strong earthquakes occur worldwide every year, causing severe damages to buildings and infrastructures.

After the severe earthquake in Kobe, Japan, in 1995, seismic construction methods have been developed and practiced rapidly in Japan.

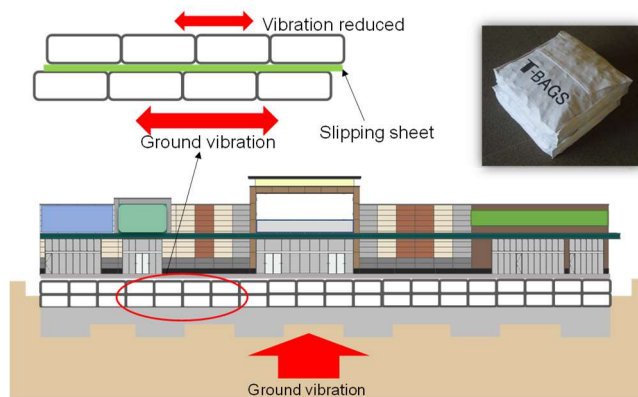

Fig. 1. Schematic arrangement of T-BAGS system.

T-BAGS is a seismic base isolation method based on the slippage between two layers of stacked sandbags (Fig. 1). The geosynthetic sheet (slip sheet) is sandwiched by two layers of sandbags. The T-BAGS installed under the building footings and slab dissipates the vibration energy during an earthquake.

In this study, experiments and numerical analyses on the performances of the T-BAGS system were carried out.

## 2 TEST DESCRIPTION OF T-BAGS SYSTEM

### 2.1 Sandbag used in T-BAGS

T-BAGS is composed of geotextile bags filled with sand. It is 400 mm in length, 400 mm in width, and 80 mm in height (Fig. 2).

A sufficient clearance, a space between the surrounding ground and T-BAGS system, at least 100 mm, should be provided for sliding (see Fig. 3). And bags filled with rubber chunks as cushions are set into the clearance to prevent buildings from colliding with the surrounding ground.

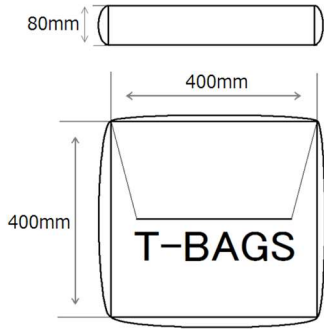

Fig. 2. Dimensions of a sandbag used for T-BAGS.

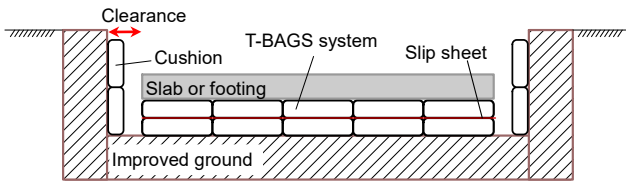

Fig. 3. Schematic arrangement of T-BAGS system.

### 2.2 Simple shear tests of sandbag

The material properties filled in the sandbag are crucial parameters controlling the seismic performance as a base isolator.

Simple shear tests were performed on one sandbag interposed between steel plates, as shown in Fig. 4 and Fig. 5 with different vertical forces  $N$ . The sandbag was bonded with the upper and lower plates. The movement of the lower plate was fixed, and horizontal force  $S$  was applied to the upper plate. Horizontal displacement  $u$  was measured at the middle height of the sandbag using a dial gage.

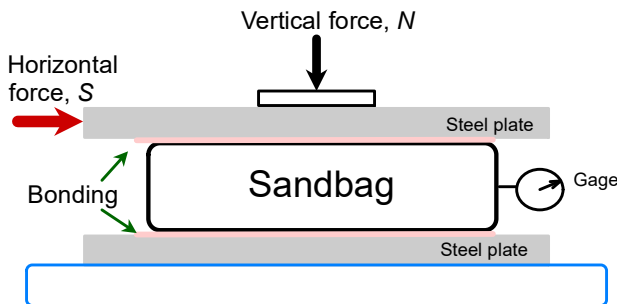

Fig. 4. Simple shear test of a sandbag.

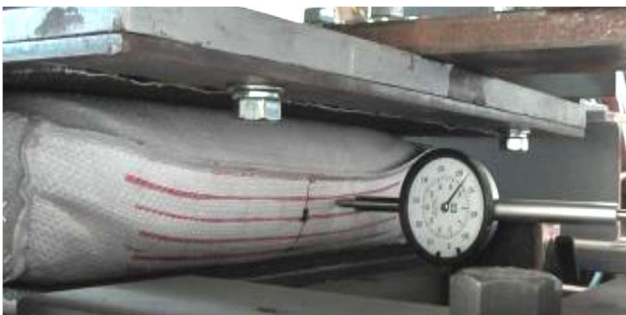

Fig. 5. Measurement of shear deformation in the shear test of a sandbag.

The  $u$  vs.  $S$  of the sandbag are shown in Fig. 6. In the tests, the vertical forces  $N$  were 5.50 kN, 3.73 kN, and 1.96 kN. Two or three tests were conducted for each vertical force  $N$ . It is seen that the repeatability of the tests is high enough.

The  $u$  vs.  $S$  in each test has an almost bi-linear relation. The yield shear force  $S_y$  increases with increasing  $N$ . Stiffness ( $\Delta S/\Delta u$ ) of the sandbag before yielding also increases with increasing  $N$ . The  $u$  at yielding points varied in a narrow range from 3 to 4 mm, in spite of  $N$ .

Even after yielding,  $S$  continued increasing without softening behavior. It is interesting to notice that the stiffness of the sandbag after yielding is almost equal regardless of  $N$ .

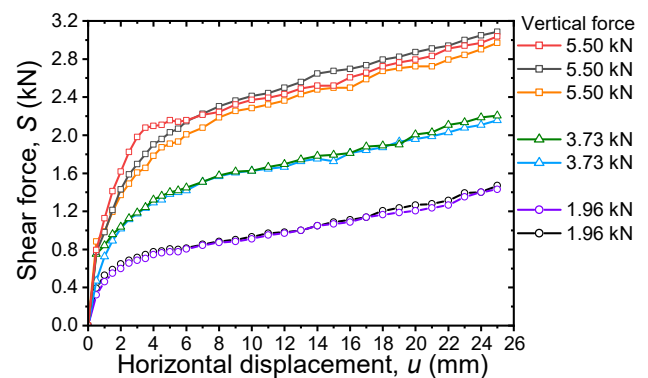

Fig. 6. Results of simple shear tests of sandbags subjected to different vertical forces.

### 2.3 Dynamic behavior of one set of T-BAGS system

The seismic behavior of the T-BAGS system is crucial in the design of the T-BAGS base isolation system. Hence, shaking table tests on one set of T-BAGS were conducted.

Fig. 7 shows the schematic view of the shaking table test on one set of T-BAGS system. As shown in Fig. 7, the sandbags were stacked up to two layers having a slip sheet between them, and a weight mass of 163 kg was placed on the upper steel plate. The test set-up was mounted on the shaking table.

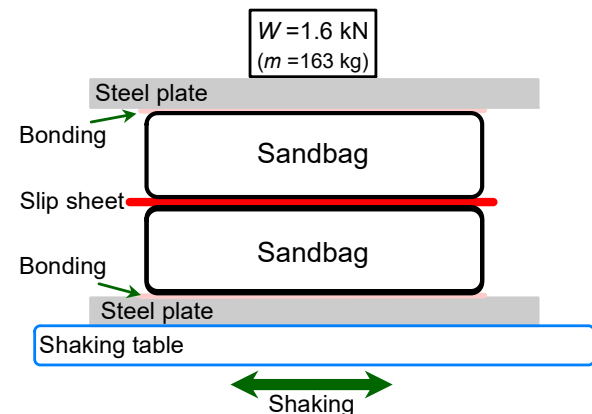

Fig. 7. The shaking table test on one set of T-BAGS system consisted of two sandbags and an intercalated slip sheet.

The slip sheet material was Poly Tetra Fluro Ethylene (PTFE), a synthetic polymer widely used in various industries. The sandbag was bonded to the upper or bottom steel plates so that slippage between the sandbag and the steel plate did not occur.

Six cases of shaking table tests were carried out. The input accelerations were harmonic waves having a frequency of 3 Hz in all cases. Only, the amplitude of the input acceleration was varied from 1 m/s<sup>2</sup> to 6 m/s<sup>2</sup> as listed in Table 1.

Table 1. Test conditions of shaking table tests on one set of T-BAGS system.

Test No.	Slip sheet material	Input acceleration	
		Frequency (Hz)	Amplitude (m/s <sup>2</sup> )
1	PTFE	3.0	1.0
2			2.0
3			3.0
4			4.0
5			5.0
6			6.0

The test results will be presented in Section 3.1, together with numerical simulations of the tests.

**2.4 Shaking table tests on six sets of T-BAGS system**

Subsequently to the tests on one set of T-BAGS, the shaking table tests on six sets of T-BAGS (Fig. 8), a more practical situation, were carried out.

Fig. 9 shows the test set-up in the shaking table tests on six sets of T-BAGS. The testing procedure was generally the same as the tests on one set of T-BAGS.

The slip sheet material was High-Density Poly Ethylene (HDPE), a corrosion-resistant thermoplastic polymer, and it is a preferable material to use underground.

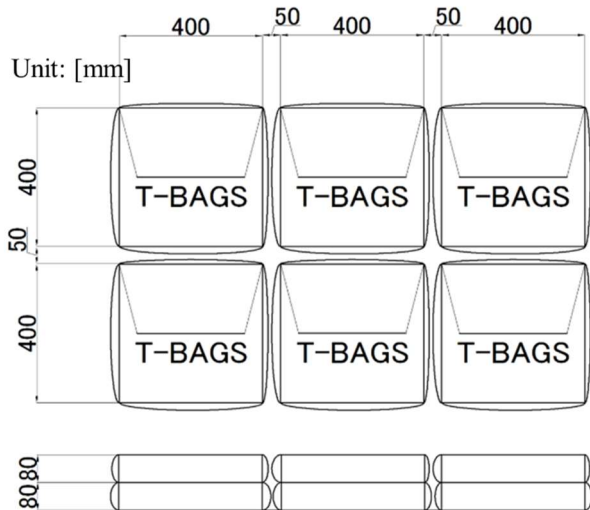

Fig. 8. Schematic view of six sets of sandbags used in shaking table tests.

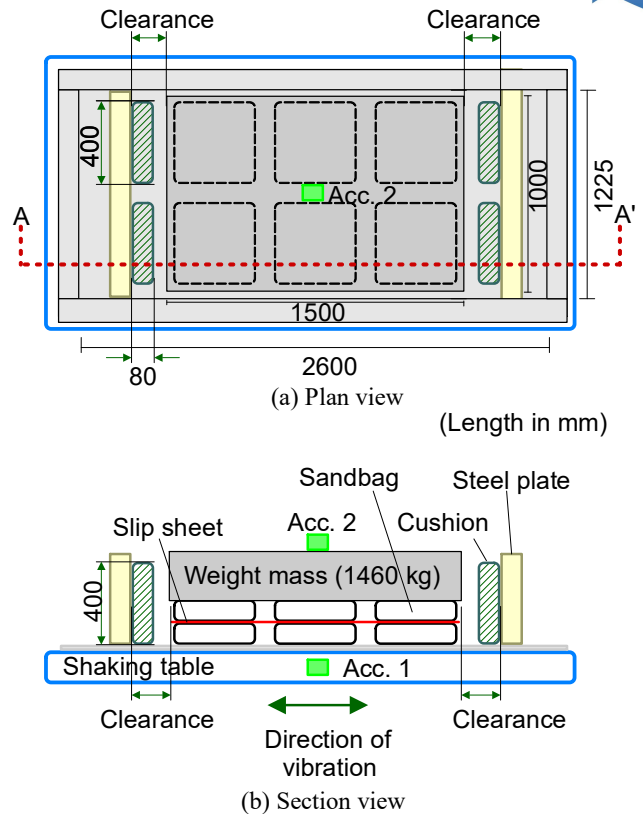

Fig. 9. Shaking table test set up of six sets of T-BAGS system.

The weight mass of 1460 kg (14.3 kN) was applied to six sets of T-BAGS to simulate vertical loads of the super-structure. Two accelerometers were set on the shaking table and on the top of the weight plate to measure the input and response accelerations, respectively. The test results will be presented in Section 3.2, together with numerical simulations of the tests.

**3 NUMERICAL ANALYSIS**

In this section, simulations of the experiments are conducted to obtain a practical design tool for the T-BAGS system.

**3.1 Numerical simulation of one set of T-BAGS system**

Fig. 10 shows the experimental condition for one set of T-BAGS and the corresponding numerical modeling.

In the 2D model, the top sandbag is treated as a rigid mass, and the slip sheet is expressed by a combination of springs in the vertical and horizontal directions (see Fig. 11). The vertical spring is linear, whereas the horizontal spring is bi-linear (see Fig. 12). The threshold resistance  $P_y$  of the horizontal spring depends on the force  $N$  in the vertical spring;  $P_y = \mu N$  where  $\mu$  is friction coefficient.

The parameters used for the interface between the two stacked sandbags are given in Table 2, and the corresponding bi-linear relation is shown in Fig. 12. These parameters were used in the analyses using TDAPIII developed by ARK Information Systems (2021).

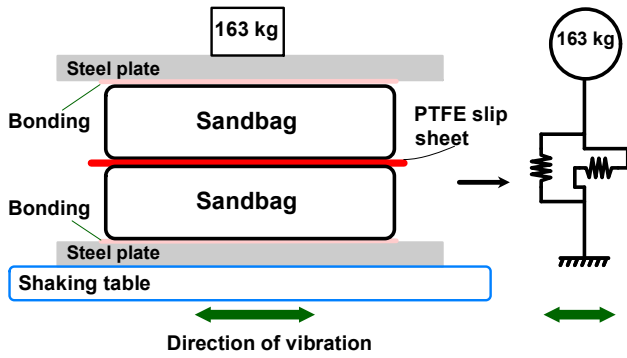

Fig. 10. Schematic diagram of experiment and numerical analysis of one set of T-BAGS system.

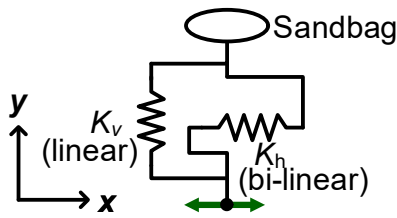

Fig. 11. Modeling of the interface between two stacked sandbags.

Table 2. Parameters used in the analysis of the experiment on one set of T-BAGS.

Parameter	Value
Vertical load, $N$ (kN)	1.6
Primary elastic modulus, $K_{h1}$ (kN/mm)	1.5
Secondary elastic modulus, $K_{h2}$ (kN/mm)	$\approx 0$
Coefficient of friction, $\mu$ (sandbag and PTFE slip sheet)	0.16
Threshold resistance, $P_y$ (kN) = $\mu \times N$	0.256

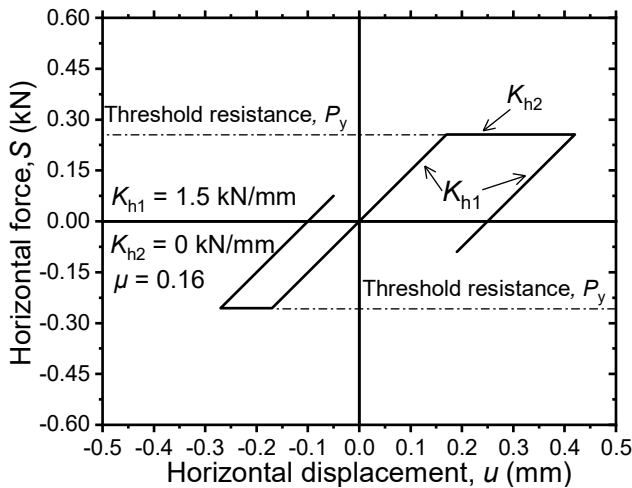
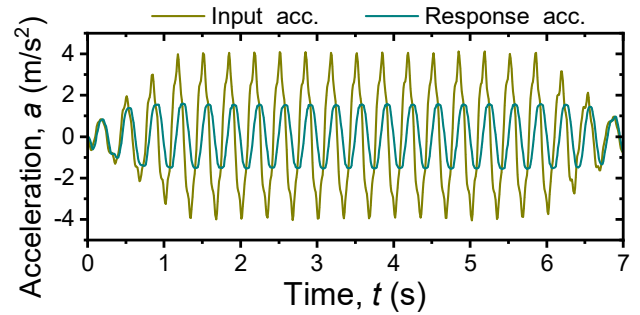

Fig. 12. Characteristics of horizontal spring used in the analysis of one set of T-BAGS.

In the analyses, the Newmark-beta numerical integration method was used with a time interval  $\Delta t = 1.667 \times 10^{-3}$  second and  $\beta = 0.25$ . Six experiments presented in Section 2.3 were analyzed.

In Fig. 13a, the results of Test No. 4, in which the amplitude of the input harmonic acceleration was  $4 \text{ m/s}^2$  with the frequency  $f$  of 3 Hz, are presented. The maximum absolute values of the response acceleration

are  $1.59$  and  $1.57 \text{ m/s}^2$  in the experiment and numerical analysis, respectively (see Fig. 13a and b). The relative horizontal displacement between the top and bottom sandbags is given in Fig. 13c.



(a) Measured

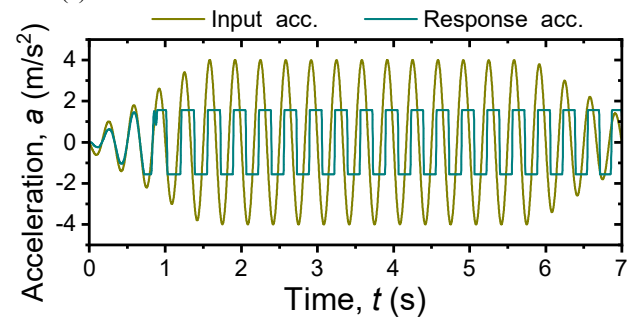

(b) Numerical

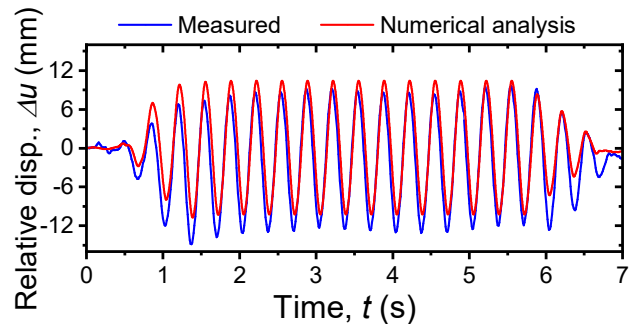

(c) Relative displacement results of measured and numerical analysis due to input acceleration.

Fig. 13. Comparison of experiment and numerical analysis results for one set of T-BAGS (Test No. 4).

Fig. 14 compares the measured and calculated maximum absolute response accelerations  $a_{max}$  in the six tests with different maximum input acceleration amplitudes  $a_{inp}$ . The calculated  $a_{max}$  levels off when  $a_{inp}$  exceeds  $2 \text{ m/s}^2$ , while the measured  $a_{max}$  continues increasing with increasing  $a_{inp}$  over  $2 \text{ m/s}^2$ . In the experiments, the rocking motion of sandbags was clearly observed visually, and the degree of the rocking motion increased with increasing  $a_{inp}$ . The measured acceleration involves acceleration caused by the rocking motion. On the other hand, the analytical model (Fig. 11) does not consider the rocking motion. Hence, the calculated results cannot explain the measured trend.

Although there is room for improving the analytical model, it is seen from Figs. 13 and 14 that the results of numerical analyses simulated well the measured results.

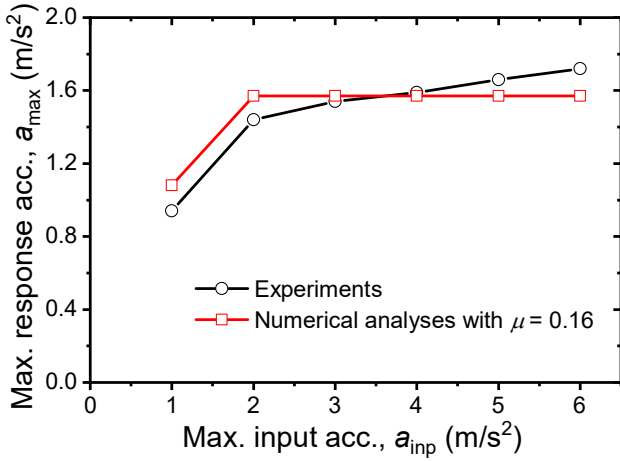

Fig. 14. Maximum input acceleration vs. maximum response acceleration for the one set of sandbags.

### 3.2 Numerical simulation of six sets of T-BAGS system

As explained in Section 2.4, the shaking table tests were carried out on six sets of T-BAGS.

Fig. 15 shows the model for the six sets of the T-BAGS system. Basically, the model is identical to the model for one set of T-BAGS system in Fig. 10, and assembles six sets by connecting them with beam elements.

The parameters used for the interface between the two stacked sandbags for each set are given in Table 3, and the corresponding bi-linear relation is shown in Fig. 16. The value of  $\mu$  of HDPE slip sheet is larger than that of the PTFE slip sheet, which was used in the experiment on one set of T-BAGS system. Fig. 17 is the input acceleration at the shaking table. This input wave is based on the experimental condition ( $a_{max} = 4 \text{ m/s}^2$  and  $f = 1.5 \text{ Hz}$ ).

Fig. 18 shows the response acceleration  $a_{res}$  vs. the relative horizontal displacement  $\Delta u$  between the upper sandbags and the shaking table measured in the experiment. Fig. 19 shows the corresponding calculated result. The calculation simulates the measured results well. A possible reason for the reasonable simulation is that the rocking motion, which was observed in the experiment on one set of T-BAGS system, was not observed in this experiment. It is expected that rocking motion can be neglected in T-BAGS systems having large areas. Hence, the proposed modeling for the T-BAGS system is accepted as a practical design tool.

The cushions were implemented in the analytical model (Fig. 9). Collision of the sandbags against the cushions did not occur in this particular experiment.

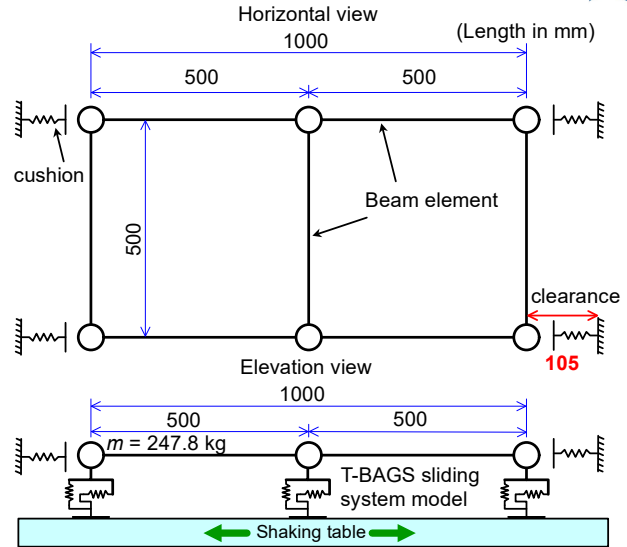

Fig. 15. Schematic view of the numerical analysis of the six sets of T-BAGS.

Table 3. Parameters used in the analysis of the experiment on six sets of T-BAGS.

Parameter	Value
Vertical load on each set of T-BAGS, $N$ (kN)	2.43
Primary elastic modulus, $K_{h1}$ (kN/mm)	0.07
Secondary elastic modulus, $K_{h2}$ (kN/mm)	$\approx 0$
Coefficient of friction, $\mu$ (sandbag and HDPE slip sheet)	0.19
Threshold resistance, $P_y$ (kN) = $\mu \times N$	0.462

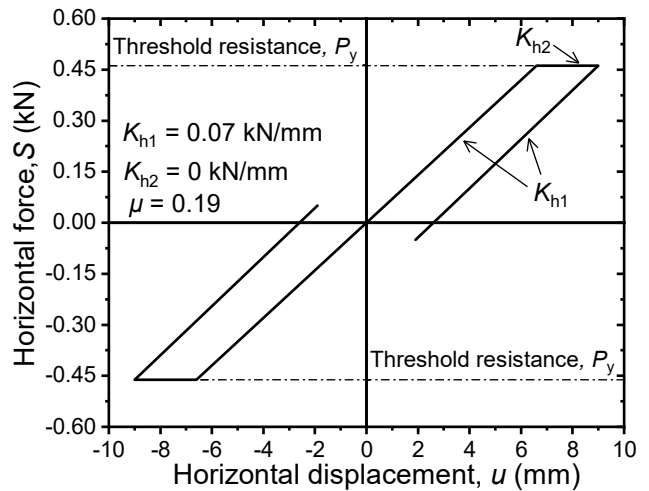

Fig. 16. Characteristics of horizontal spring used in the analysis of six sets of T-BAGS.

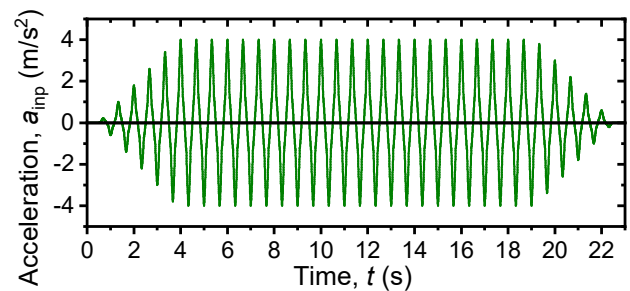

Fig. 17. Input acceleration used in the analysis.



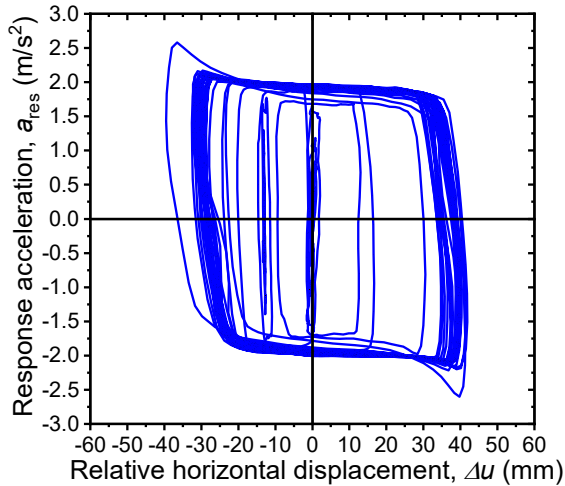

Fig. 18. Measured acceleration-displacement hysteresis loop.

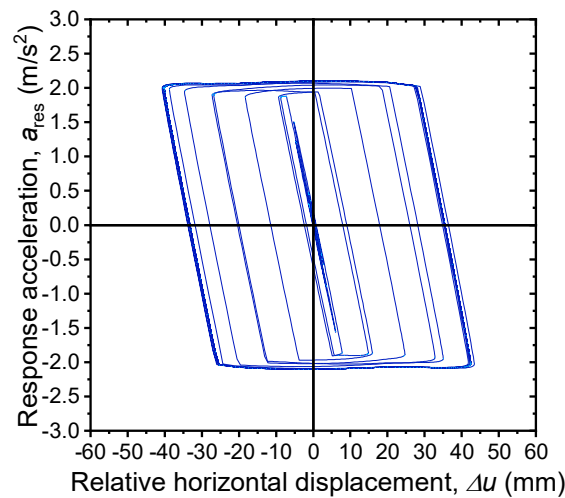

Fig. 19. Calculated acceleration-displacement hysteresis loop.

### 3.3 Numerical analysis of six sets of T-BAGS system subjected to an actual earthquake

In this section, the performance of the T-BAGS system (Figs. 8, 9, and 15) is demonstrated against an actual earthquake record.

Fig. 20 is the record of the Tohoku earthquake, Mito station EW (2011), which is used for the input acceleration at the base of six sets of the T-BAGS system. Fig. 21 shows the time history of response acceleration at the upper sandbags. The maximum value of  $a_{res}$  is reduced to  $2.44 \text{ m/s}^2$ , about 31% of the maximum value of  $a_{inp} = 7.86 \text{ m/s}^2$ .

The time history of relative horizontal displacement  $\Delta u$  between the top and bottom sandbags is shown in Fig. 22. The maximum value of  $\Delta u$  is 40 mm. The residual relative displacement is about 11 mm. These values would not increase even if the size of the T-BAGS system increases.

## 4 CONCLUDING REMARKS

In this study, a series of shaking table tests on T-BAGS systems and their numerical simulations were carried out. The results of the experiments clearly showed that the T-BAGS system is a very efficient

seismic base isolation system.

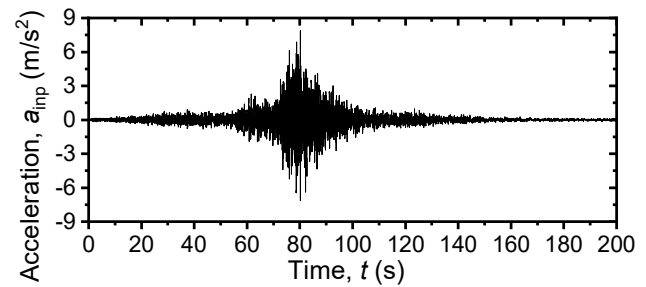

Fig. 20. Input acceleration used in the numerical analysis (Tohoku earthquake, K-NET, Mito station EW, 2011).

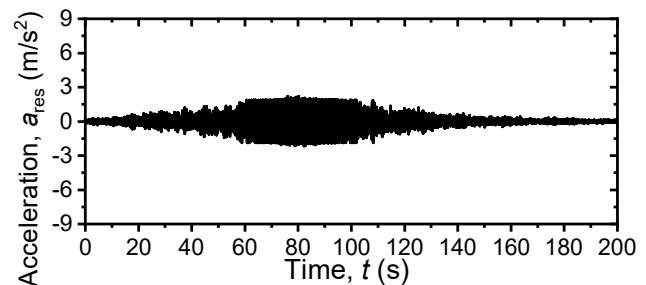

Fig. 21. Response acceleration at the upper sandbags.

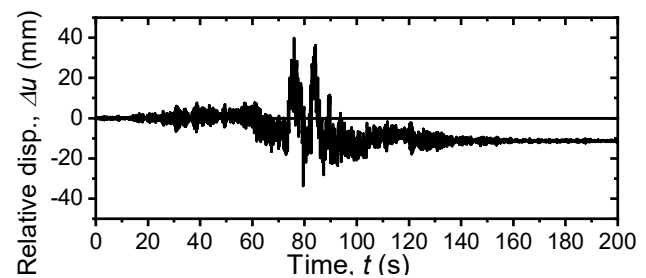

Fig. 22. Relative displacement between the upper and lower sandbags.

A simplified but reliable numerical approach was proposed. The experimental results were simulated well using the proposed numerical method.

The performance of the T-BAGS system subjected to the Tohoku earthquake was examined using the proposed numerical method. It was shown again that the T-BAGS seismic base isolation system works well against severe earthquakes.

## REFERENCES

- 1) ARK Information Systems, INC. (2021): TDAPIII Manuals.
- 2) Takeuchi Construction Inc. (2021): Website <https://www.takeuchi-const.co.jp/en/>
- 3) The Center for Better living in Japan (2017): High strength sandbag (high strength T-BAGS stack) seismic base semi-isolation method for residential structures (in Japanese).
- 4) K-NET strong-motion seismograph network (2021): Website: <https://www.kyoshin.bosai.go.jp/>